

HOTEL CAFÉ ROYAL
REGENT STREET, LONDON



EVENTS







Hotel Café Royal has historically been a gathering place for conversation, and has welcomed intellectuals, artists, writers, rock stars and royalty throughout its storied past. Everyone from Oscar Wilde to Virginia Woolf to Winston Churchill, have met at the location for both business and pleasure.

Being located between the commercial hub of Mayfair, the political and commercial district of St James and the media capital of Soho means there is no better location for minds to meet than at Hotel Café Royal.

Within the hotel, grand historic areas have been sensitively restored while 159 guestrooms and suites (including seven signature suites) have been created in a contemporary yet refined style. Continuing its celebrated legacy of excellent hospitality and dining, the hotel offers a selection of restaurants and bars including the Oscar Wilde Lounge for award winning Afternoon Tea, Brasserie Lutetia, Green Bar, Cakes and Bubbles, led by world renowned pastry chef, Albert Adrià and Alex Dilling at Hotel Café Royal. The hotel also has a holistic wellbeing concept, Akasha, which features a state-of-the-art-gym, large lap pool, sauna, jacuzzi and private Hammam, as well as a wide range of treatments.





Pompadour Ballroom

The Pompadour Ballroom is the largest event space at Hotel Café Royal. The Grade II listed room and its original, ornate detailing have been sensitively restored to create a grand space for celebrations such as receptions, launches, fashion shows and weddings. The Louis XVI style room has a series of fluted Corinthian pilasters and mirrored panels with gilded frames, and its ceiling is decorated with frescos depicting scenes of love.

At the far end of the room, large double doors open on to a pillared outdoor terrace with views on to the panoramic sweep of Regent Street. The area is equipped with patio heaters and can be dressed to include poseur tables or additional seating.

USABLE AREA 176 SQM INDOORS | 63 SQM TERRACE

LENGTH 9.2M

WIDTH 24.4M

HEIGHT 3M (CHANDELIER - 2.10M)

CONFIGURATIONS

RECEPTION: 250

BANQUETING: 110

DINNER & DANCE: 80

BUFFET (STANDING): 180

BUFFET (SEATED): 80

THEATRE STYLE: 120 WITH AV

CABARET STYLE: 63

CLASSROOM STYLE: 80

BOARDROOM STYLE: 54

HOLLOW SQUARE: 51

U-SHAPE: 55

KEY FEATURES

- HISTORIC GRADE II LISTED ROOM
- TRIPLE-GLAZED WHISPER QUIET
- VIEWS OF REGENT STREET
- HIGH SPEED COMPLIMENTARY WI-FI
- NATURAL DAYLIGHT WITH FLOOR TO CEILINGS WINDOWS
- LARGE TERRACE
- THREE-PHASE POWER
- ABILITY TO DRESS SPACE AS DESIRED
- 12 MIDNIGHT LICENCE, EXTENSION TO 1AM POSSIBLE UPON REQUEST

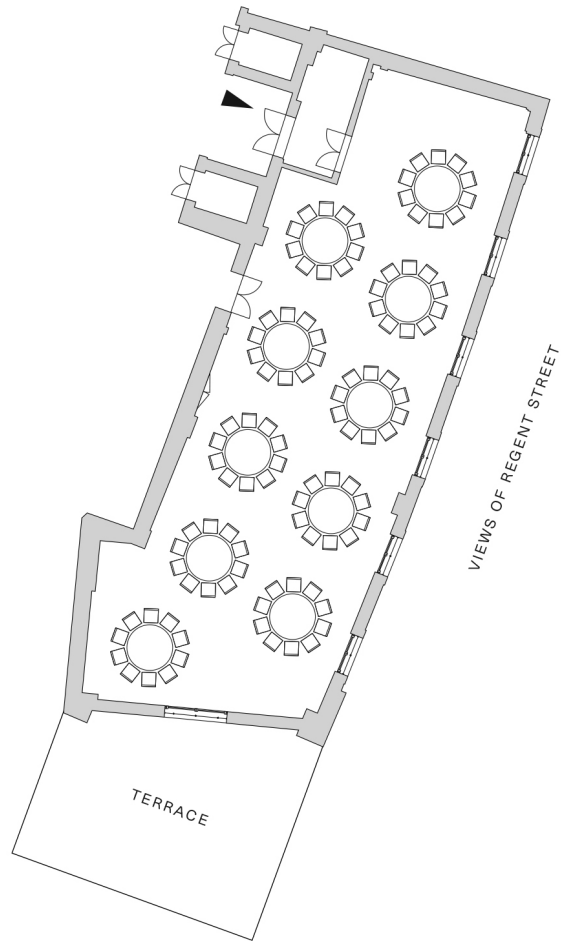







Queensberry

Within the meeting centre at Hotel Café Royal, the Queensberry room is a generous space spanning the bottom sweep of Regent Street, which is ideal for theatre style conferences or banqueting dinners. Large floor to ceiling windows give views over Piccadilly Circus and fumed oak wall and ceiling panels conceal state-of-the-art technology accessed easily by touch screen, wall mounted control panels.

USABLE AREA 141 SQM
LENGTH 22.1M
WIDTH 6.2M WIDE
HEIGHT 2.19M

CONFIGURATIONS

RECEPTION: 150
BANQUETING: 100
DINNER & DANCE: 70
BUFFET (STANDING): 140
BUFFET (SEATED): 70
THEATRE STYLE: 150
CABARET STYLE: 56
CLASSROOM STYLE: 90
BOARDROOM STYLE: 54
HOLLOW SQUARE: 36
U-SHAPE: 30

KEY FEATURES

- TRIPLE-GLAZED AND ACOUSTIC DOORS FOR WHISPER QUIET
- VIEWS OF REGENT STREET AND PICCADILLY CIRCUS
- MOTORISED SHEER AND BLACKOUT CURTAINS
- HIGH SPEED COMPLIMENTARY WI-FI
- NATURAL DAYLIGHT WITH FLOOR TO CEILINGS WINDOWS
- DIGITAL TOUCHSCREEN CONTROL FOR CURTAINS, LIGHTS, SOUND AND AIR CONDITIONING
- 12 MIDNIGHT LICENCE, EXTENSION TO 1AM POSSIBLE UPON REQUEST
- FULLY INTEGRATED AV SYSTEM AT AN ADDITIONAL COST
(CEILING HUNG VIDEO PROJECTOR AND DROP DOWN PROJECTION
SCREEN, CEILING SPEAKERS, CONNECTION PANEL)

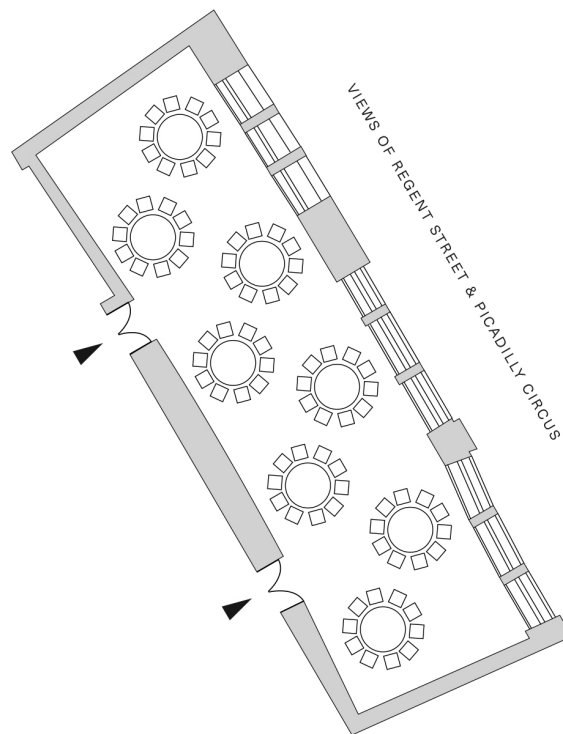



Soho

The Soho is an intimate and discreet meeting space at Hotel Café Royal. The modest size makes it ideal for board and business meetings, as well as for private dining for smaller gatherings. It is flooded with natural daylight through windows overlooking Glasshouse Street.

KEY FEATURES

- TRIPLE-GLAZED AND ACOUSTIC DOORS FOR WHISPER QUIET
- VIEWS OF GLASSHOUSE STREET
- MOTORISED SHEER AND BLACKOUT CURTAINS
- HIGH SPEED COMPLIMENTARY WI-FI
- DIGITAL TOUCHSCREEN CONTROL FOR CURTAINS, LIGHTS, SOUND AND AIR CONDITIONING
- FULLY INTEGRATED AV SYSTEM AT AN ADDITIONAL COST (CEILING HUNG VIDEO PROJECTOR AND DROP DOWN PROJECTION SCREEN, CEILING SPEAKERS, CONNECTION PANEL)

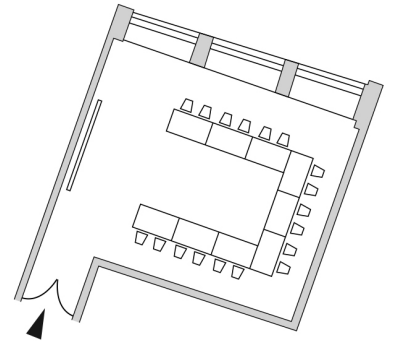

Mayfair

The Mayfair is the perfect sized room for intimate gatherings or moderately sized meetings. Created with fumed oak panels, this space features large windows offering natural daylight overlooking Glasshouse Street.

KEY FEATURES

- TRIPLE-GLAZED AND ACOUSTIC DOORS FOR WHISPER QUIET
- VIEWS OF GLASSHOUSE STREET
- MOTORISED SHEER AND BLACKOUT CURTAINS
- HIGH SPEED COMPLIMENTARY WI-FI
- DIGITAL TOUCHSCREEN CONTROL FOR CURTAINS, LIGHTS, SOUND AND AIR CONDITIONING
- FULLY INTEGRATED AV SYSTEM AT AN ADDITIONAL COST (CEILING HUNG VIDEO PROJECTOR AND DROP DOWN PROJECTION SCREEN, CEILING SPEAKERS, CONNECTION PANEL)

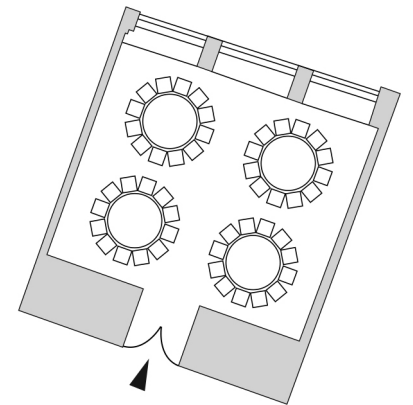



USABLE AREA 59 SQM
LENGTH 8.5M
WIDTH 6.9M
HEIGHT 2.35M

CONFIGURATIONS

RECEPTION: 50
BANQUETING: 40
BUFFET (STANDING): 50
BUFFET (SEATED): 30
THEATRE STYLE: 40
CABARET STYLE: 28
CLASSROOM STYLE: 24
BOARDROOM: 20
HOLLOW SQUARE: 21
U-SHAPE: 18

USABLE AREA 58 SQM
LENGTH 8.4M
WIDTH 6.9M
HEIGHT 2.38M

CONFIGURATIONS

RECEPTION: 50
BANQUETING: 40
BUFFET (STANDING): 50
BUFFET (SEATED): 30
THEATRE STYLE: 40
CABARET STYLE: 28
CLASSROOM STYLE: 24
BOARDROOM: 20
HOLLOW SQUARE: 21
U-SHAPE: 18

Nicols

The Nicols is an elegant boardroom style room created in fumed oak panels within the meeting centre. It features an arched window which offers views over Glasshouse Street.

KEY FEATURES

- TRIPLE-GLAZED AND ACOUSTIC DOORS FOR WHISPER QUIET
- VIEWS OF GLASSHOUSE STREET
- MOTORISED SHEER AND BLACKOUT CURTAINS
- HIGH SPEED COMPLIMENTARY WI-FI
- BOX FLOOR POWER SOCKETS
- DIGITAL TOUCHSCREEN CONTROL FOR CURTAINS, LIGHTS, SOUND AND AIR CONDITIONING
- FULLY INTEGRATED AV SYSTEM AT AN ADDITIONAL COST (CEILING HUNG VIDEO PROJECTOR AND DROP DOWN PROJECTION SCREEN, CEILING SPEAKERS, CONNECTION PANEL)

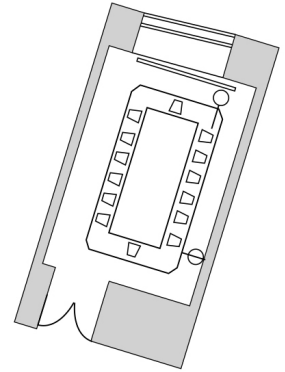

Nash

The Nash is an intimate boardroom, created with fumed oak panels. Large windows overlook the elegant sweep of Regent Street and bask the room in natural daylight.

KEY FEATURES

- TRIPLE-GLAZED AND ACOUSTIC DOORS FOR WHISPER QUIET
- VIEWS OF GLASSHOUSE STREET
- MOTORISED SHEER AND BLACKOUT CURTAINS
- HIGH SPEED COMPLIMENTARY WI-FI
- BOX FLOOR POWER SOCKETS
- DIGITAL TOUCHSCREEN CONTROL FOR CURTAINS, LIGHTS, SOUND AND AIR CONDITIONING
- FULLY INTEGRATED AV SYSTEM AT AN ADDITIONAL COST (CEILING HUNG VIDEO PROJECTOR AND DROP DOWN PROJECTION SCREEN, CEILING SPEAKERS, CONNECTION PANEL)

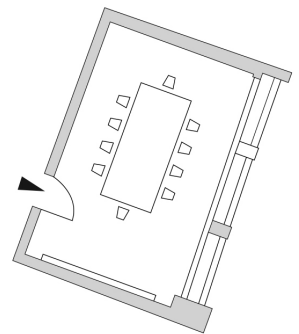



USABLE AREA 32 SQM
LENGTH 7.2M
WIDTH 4.4M
HEIGHT 2.38M

CONFIGURATIONS
RECEPTION: 20
BANQUETING: 14
THEATRE STYLE: 20
BOARDROOM: 14



USABLE AREA 26 SQM
LENGTH 6.4M
WIDTH 4M
HEIGHT 2.49M

CONFIGURATIONS
BOARDROOM: 10

Capacity Chart

	NASH	NICOLS	MAYFAIR	SOHO	QUEENSBERRY	POMPADOUR
Size (sq.ft./sqm)	280 sq.ft/ 26sqm	344 sq.ft/ 32sqm	642 sq.ft/ 58sqm	635 sq.ft/ 59sqm	1,517 sq.ft/ 141sqm	1,894 sq.ft/ 176sqm
Reception	-	20	50	50	150	250
Banqueting	-	16	40	40	100	110
Dinner & Dance	-	-	-	-	70	80
Buffet (standing)	-	-	50	50	140	180
Buffet (seated)	-	-	30	30	70	80
Theatre Style	-	20	40	40	150	120
Cabaret Style	-	-	28	28	56	63
Classroom Style	-	-	24	24	90	80
Boardroom	10	14	20	20	54	54
Hollow Square	-	-	21	21	36	51
U-Shape	-	-	18	18	30	55

FIRST FLOOR

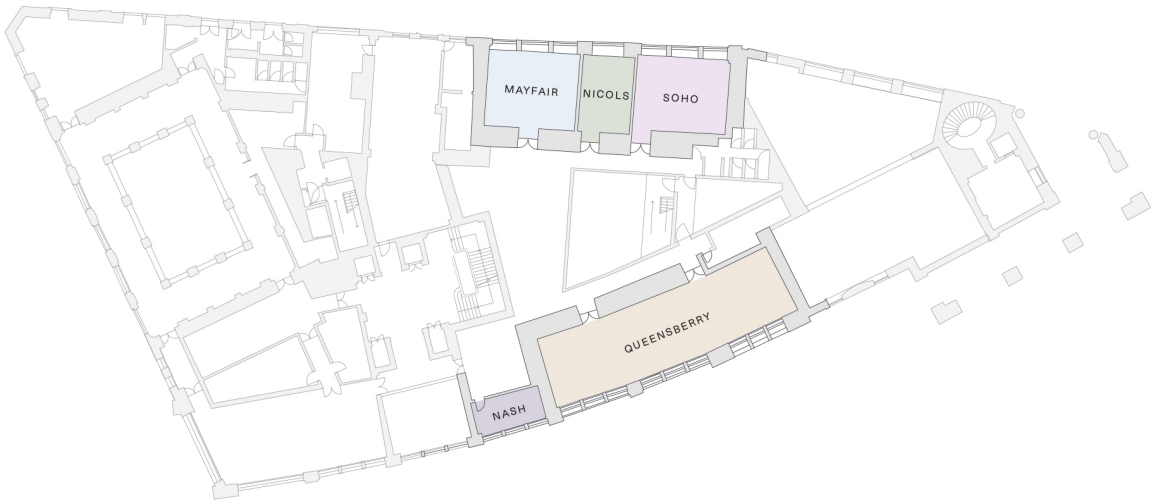

SECOND FLOOR





HOTEL CAFÉ ROYAL

68 Regent Street, London, W1B 4DY

United Kingdom